

Multiple Oppositions: Theoretical Foundations for an Alternative Contrastive Intervention Approach

A. Lynn Williams

East Tennessee State University,
Johnson City

A multiple opposition approach to phonological intervention is described as an alternative contrastive approach for the treatment of severe speech disorders in children. The development and theoretical constructs of this approach are presented within the context of a clinical case study. The multiple opposition approach is based on the premise that the *systemic* level of phonological organization is essential in the description and intervention of disordered sound systems. Phonological descriptions identify phoneme collapses, which

are viewed as phonologic strategies developed by the child to accommodate a limited sound system relative to the full adult system of the ambient language. Intervention is then directed systemically across the child's entire rule, or collapse, by using larger treatment sets of multiple oppositions rather than by one contrast at a time.

Key Words: phonological disorders, phonological treatment, treatment efficacy, multiple oppositions

Speech-language pathologists in the last 2 to 3 decades have incorporated a conceptual-linguistic approach in the treatment of phonological disorders in children. One method that has commonly been used is minimal contrast therapy (Cooper, 1968; Elbert, Rockman, & Saltzman, 1980; Ferrier & Davis, 1973; Weiner, 1981a). This treatment approach selects pairs of words that are distinguished by a single consonant or vowel but that are produced as homonyms by the child. Intervention involves selecting word pairs that contrast the child's error production with the target sound in a one-to-one comparison. Frequently, however, children with moderate-to-severe phonological disorders collapse *several* adult phonemes to a single sound; thus, the contrastive function of *many* adult sounds is absent and their speech intelligibility is thereby critically reduced (Camarata & Gandour, 1984; Grunwell, 1995; Weiner, 1981b; Williams, 1993).

Recently, an alternative approach to contrastive minimal pairs has been introduced that may be a more effective clinical option for phonological intervention. The approach of multiple oppositions directly addresses the multiple absence of adult sounds that results from extensive phoneme collapses. When the contrastive function of several sounds is absent, the result is homonymy. That is, two or more words are pronounced alike, but have different meanings. For example, a child who collapses the voiceless obstruents /s, ʃ, k, tʃ/ to [t] would pronounce the words *sip*, *ship*, *Kip*, and *chip* all as [tɪp]. Although the meanings are different and the pronunciations differ from the adult

pronunciations, the child produces them as homonyms. This collapse results in reduced intelligibility and thus communication breakdowns. Not surprisingly, the more extensive the collapse relative to the adult sound system, i.e., the more sounds produced as a single sound by the child, the greater the impact on speech intelligibility. In a multiple opposition approach, the child is confronted with several sounds simultaneously within a phoneme collapse. The goal is then to induce multiple phonemic splits that have been previously collapsed in order to reduce the homonymy in the child's system. Multiple oppositions addresses homonymy directly with the use of contrastive pairs while using larger treatment contrast sets than are used with the singular contrastive approach of minimal pairs. The use of larger treatment sets in multiple oppositions may lead to several new phonemic contrasts being added to a child's system. Thus, multiple oppositions has a potential advantage over singular contrastive models of phonological intervention in terms of shortened length of treatment, improved intelligibility, and more efficient intervention.

Phonological intervention from a multiple opposition perspective views sound systems, regardless of whether they are typically developing or disordered, as being constructed and elaborated in precise and systematic ways (Gierut, 1990b). Thus, a disordered sound system will be organized according to a phonetically systematic set of combinations of phonetic features constituting symmetrical systems that are consistent with the phonologies of natural languages (Grunwell, 1997). Further, patterns of phonemic

collapse are reflections of restrictions of the child's phonological system. Finally, the acquisition of new phonemic contrasts will be restricted by the nature of the child's phonological system (Ingram, 1991).

Support for a multiple opposition approach to phonologic intervention is indicated in the construct of broad training, as discussed by Elbert and Gierut (1986). According to Elbert and Gierut, "training broad" incorporates intervention that is distributed across a large and varied treatment set. The rationale of broad training is to expose the child to the extent and range of training exemplars applicable to a particular rule set. Broad training is juxtaposed to deep training in which the child receives massed practice on a limited range of treatment exemplars. The goal of deep training is based primarily on stabilizing the accuracy of sound production rather than on rule learning. Macher (1990) compared the constructs of broad training to deep training in the phonological intervention of two error patterns in two children with moderate-to-severe phonological impairments. The children received intervention on the same target sounds, and the sounds were equated with regard to level of productive phonological knowledge. Specifically, all target sounds were characterized as Type 6 knowledge, or inventory constraints, according to Gierut, Elbert, and Dinnsen's (1987) levels of productive phonological knowledge. One child received deep training on [ʃ] word-initially and broad training for [tʃ, dʒ] word-initially. The other child received broad training on [s, ʃ] word-initially and deep training on [tʃ] word-initially. The results indicated that similar treatment outcomes for both treatment approaches were obtained by the child with the moderate phonological disorder, but broad training resulted in significantly higher generalization performance for the child with the severe phonological disorder.

Additional support for the multiple opposition approach is the manner in which the child's phonological rules are addressed in treatment. The larger treatment sets of the multiple opposition approach incorporate the child's rule, or phoneme collapse, more systemically than would be accomplished by singular contrastive approaches. A singular contrastive approach, such as minimal pairs, would select only one sound to be contrasted, and learned, at a time. In the example given earlier of a child who collapses voiceless obstruents /s, ʃ, k, tʃ/ to [t], the minimal pair approach may identify [t] ~ [k] and even [t] ~ [s] as targets for remediation. Treatment pairs would be developed that contrasted each of these targets singly and individually with [t]. Minimal pairs, such as "tight" ~ "kite"; "tan" ~ "can"; "two" ~ "coo" and "tea" ~ "see"; "toe" ~ "sew"; and "tack" ~ "sack" would be developed for [t] ~ [k] and [t] ~ [s], respectively. This approach to intervention addresses each incorrect sound separately and independently. Consequently, each target sound is treated as a separate and independent error pattern. Thus, the minimal pair approach misses the fact that *both* errored sounds, that is, [k] and [s], are related to a larger, unified error pattern.

The constructs of singular oppositions and multiple oppositions pose an interesting learnability question. Specifically, is it easier to learn new sound contrasts and

reorganize the sound system using singular opposition approaches or a multiple opposition approach? Two logical, though competing, hypotheses for the phonological learnability associated with each intervention model can be considered. The first hypothesis would indicate that single oppositions are easier to learn. This is because there is only a single contrast to be learned, so the focus in treatment is greater; there is less semantic load in terms of treatment exemplars; and there are fewer demands on attention and memory. These models of intervention are based on the premise that the target contrast is generalizable to other phonetically similar sounds that are affected by the child's error pattern.

The opposing hypothesis would indicate that single oppositions would be relatively more difficult to learn and integrate phonemically. Although the child would have only a single new contrast to learn, it is fragmented from a larger, more diverse rule pattern and thus is more difficult to integrate into a new rule set. This second hypothesis suggests that multiple oppositions would present the child with the range and diversity of the new contrasts, which would therefore facilitate discovery of the extent of the new rule to be learned and increase generalization. This assumption proposes that learnability of multiple sound contrasts will be easier for a child to systematically reorganize his/her sound system than when intervention is provided on a single contrast that is isolated from the child's rule set.

In sum, these two models of phonological intervention offer different perspectives on the problem of learnability. Learning single contrasts may be relatively easy for the child in terms of semantic load, focus, and attention in treatment, but learning parts of the whole rule may be more difficult and may limit the child's ability to integrate one new contrast into phonologically reorganizing an entire rule set. Multiple oppositions, on the other hand, may require greater focus and attention from the child in learning the range and extent of the new phonological rule, but exposure to the entire rule may facilitate learning and the integration of the contrasts into a new rule is more efficient.

For purposes of illustration only, a case study will be presented as a foundation for understanding the theoretical constructs in the development of a multiple opposition approach to phonological intervention. In this case study, there was little or no change with a minimal pair approach, which led to the development of an intervention approach that shifted to the use of multiple oppositions. It is important to note that this case does not demonstrate the validity of the multiple opposition approach as compared to a singular contrastive approach and is, therefore, not sufficient to document treatment efficacy. However, the case illustrates the logical development of a multiple opposition approach and serves as an example for understanding the theoretical differences between a singular and multiple opposition approach to treatment. The treatment results suggest that constructs of broad training and systemic intervention in the motivation of a multiple opposition approach to phonological intervention (a) encompass larger treatment sets of multiple phonemic contrasts and (b) provide intervention across a broader

spectrum of a child's error pattern, rule, or phoneme collapse. The treatment outcomes will be discussed within a theoretical framework for a multiple opposition approach.

Case and Procedural Information

Michelle was a 3-year, 5-month-old girl who was seen for her first semester of speech intervention at a university speech and language clinic. She exhibited a functional speech disorder of a non-organic nature, had normal hearing and cognition, and was from a monolingual English-speaking family.

A relational and independent phonological analysis was completed on a 245-item single-word probe before treatment using procedures described by Williams (1993). This probe sampled all English phonemes a minimum of five times in each word position and elicited potential minimal pairs. Results from the phonological analysis indicated that Michelle frequently collapsed multiple target phonemes into one phone. As shown in Figure 1, Michelle had three patterns that involved primarily voiceless fricatives, affricates, and glides. These patterns appeared to be determined by the word position of the target sounds. Word-initially, Michelle collapsed glides and two voiceless fricatives to the liquid [l]. Intervocally, primarily voiceless fricatives and both affricates were collapsed to the glottal glide [h]. Word-finally, primarily voiceless fricatives and both affricates were collapsed to the voiceless velar fricative [ɣ]. Based on this pattern of production, minimal contrast therapy was initiated to remediate word-initial [s, ʃ, w]. Each of the target sounds was trained in five separate contrastive minimal pairs for each of the three target sounds, resulting in a total of 15 contrastive pairs. The target contrasts included $l \sim s / \# _$; $l \sim ʃ / \# _$; and $l \sim w / \# _$.

A generalization probe was constructed to measure learning of the target sounds in untreated words and was administered before treatment to establish baseline performance and then at the end of every third treatment session to measure generalization learning. The probe consisted of 10 items each of the target sounds in the trained position.

Clinical Outcomes and Revisions

Figure 2a illustrates Michelle's training performance on the three target sounds. Notice that her baseline performance revealed that she inconsistently produced [w] correctly before training, but did not produce any target [s] or [ʃ] probe items correctly before training. Following initiation of treatment with the minimal contrast approach, Michelle's performance on [w] continued to improve. For target [s, ʃ], however, Michelle's performance remained low for nine treatment sessions, or 5 weeks, with little or no improvement. At this point, the treatment approach was reevaluated to determine what changes, if any, could be made that may facilitate Michelle's learning of [s, ʃ].

Recall from Figure 1 that Michelle's error pattern for the three target sounds was the same. That is, she collapsed all three sounds to the sound [l]. Thus, even though training was provided on each of these sounds individually, they represented the same error pattern. Given the fact that

FIGURE 1. Phoneme collapses before treatment.

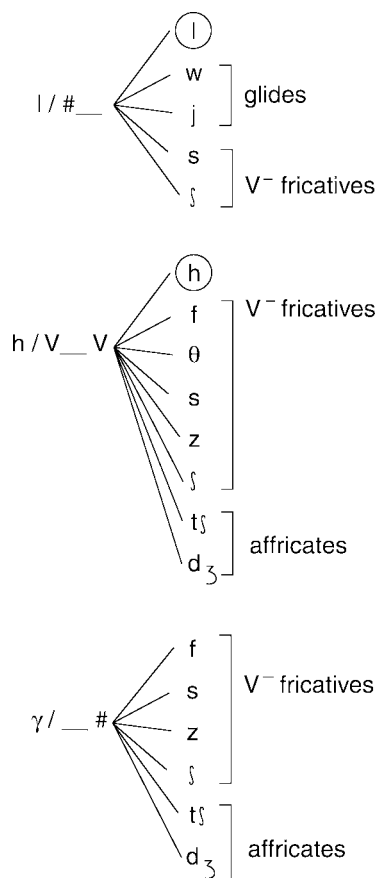

these sounds were related with regard to Michelle's error inventory, it was decided that intervention would change to encompass her error pattern. Intervention, therefore, was directed *across* the error pattern rather than training each error in isolation.

Intervention shifted from contrasting each target sound in minimal pairs to a multiple oppositions approach that contrasted all target sounds with the errored substitution. These multiple oppositions incorporated a four-way contrast that provided training across Michelle's error pattern. The new treatment oppositions for [l] ~ [s, ʃ, w] / # _ are presented in Figure 3. This four-way contrast encompassed contrastive differences of place, voice, and manner (voiced alveolar liquid ~ voiceless alveolar and palatal fricatives and voiced labio-velar glide). The resulting oppositions represent homonymous words in Michelle's lexical inventory. Five oppositional sets were incorporated in training these phoneme collapses.

Figure 2b shows Michelle's previous training performance along with her performance after intervention when the multiple oppositions approach was introduced. As shown in this figure, Michelle demonstrated significant and immediate improvement after the initiation of multiple opposition treatment. Michelle quickly met treatment criteria for all target sounds and treatment shifted from word to sentence level. Her accuracy on [ʃ] began to decline.

FIGURE 2. (a) Treatment results on word-initial /s, f, w/. (b) Treatment results following introduction of multiple oppositions.

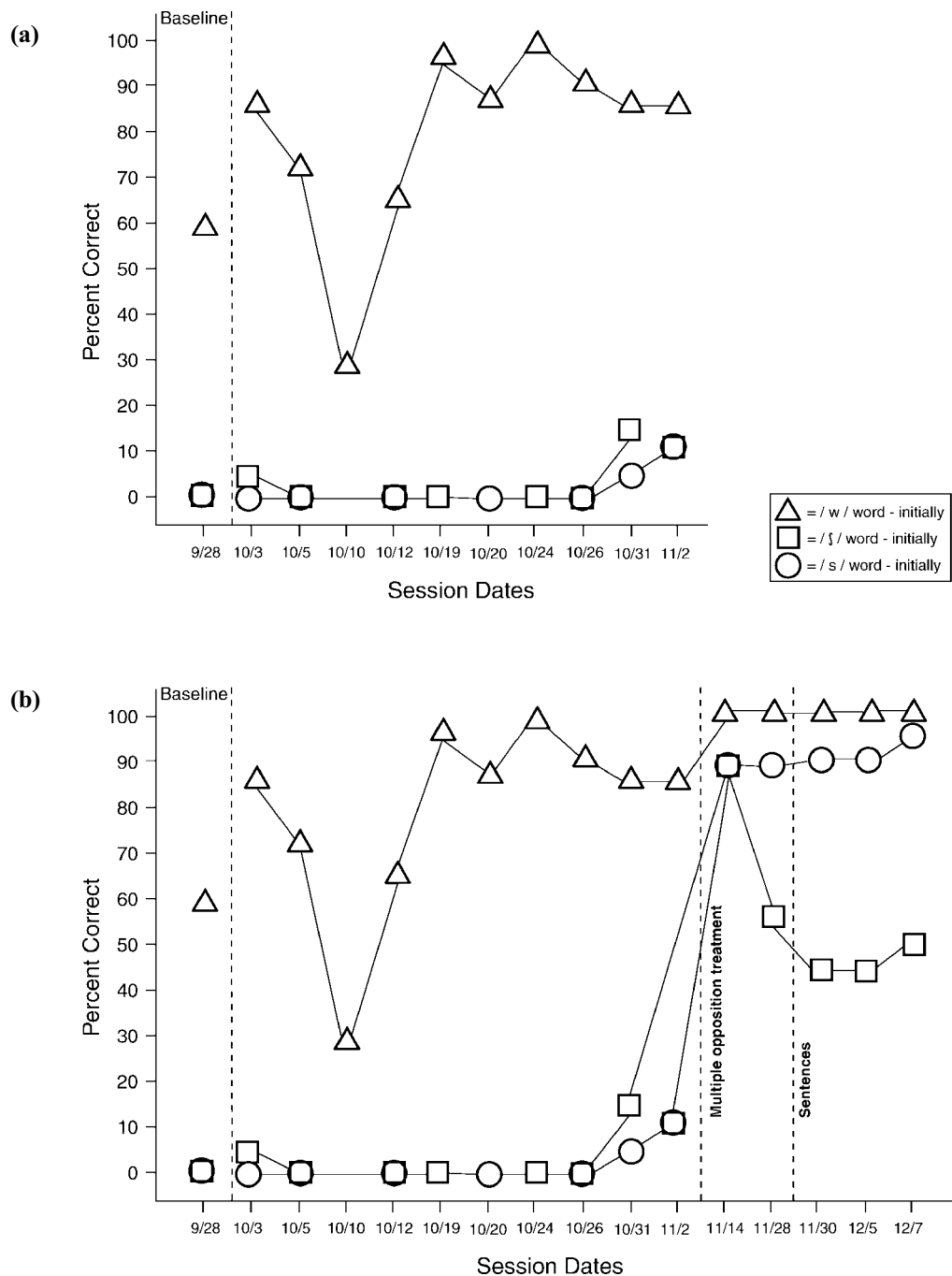

However, her incorrect productions did not regress to the original substitution of [l]. Instead, Michelle produced [s] for /f/, which represents a closer approximation to the target than her original substitution error. That is, as compared to [l], the error [s] shares all features with [f] except place.

Figure 4 illustrates Michelle's generalization performance on the untrained [s, f, w] probe items. Again, significant improvement was observed after multiple opposition treatment was initiated.

At the end of the academic semester, or 15 treatment sessions, a second phonological analysis was completed. Phonological reorganization was apparent in the comparison of the phoneme collapses pre- and post-treatment, as shown in Figure 5. Not only did improvement occur on trained sounds in trained positions, but improvement also extended to target and untargeted sounds in untrained positions. As shown in this figure, the three phoneme collapses were eliminated or significantly reduced.

FIGURE 3. Multiple opposition contrasts for phonological intervention.

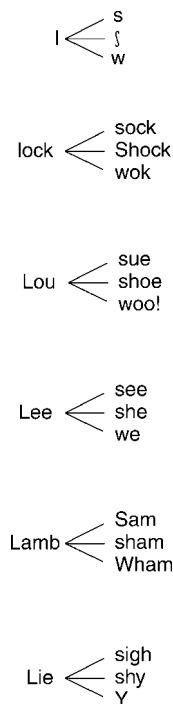

FIGURE 4. Generalization learning curves for word-initial /s, ʃ, w/.

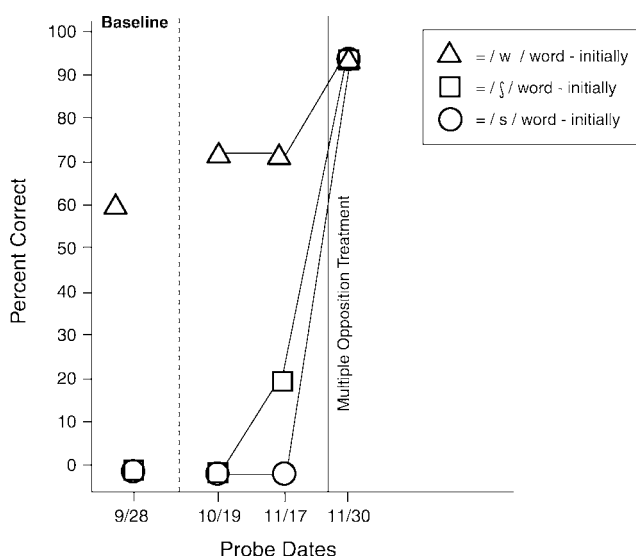

Figure 6 represents the phonological restructuring that was present following intervention. As indicated in this figure, Michelle added four fricatives [f, v, s, z] to her inventory following treatment. The phonological restructuring evident in her phoneme collapses indicates that Michelle used the new fricatives to represent a more restricted phoneme collapse. Fewer sounds were collapsed,

generally only the target plus one additional sound. Further, the collapse appeared to be based primarily on the voicing distinction and reflected a more developmental error pattern as compared to the idiosyncratic collapses before treatment.

Discussion

The data from this case study describe the theoretical constructs for phonological intervention in the development of the multiple opposition approach. Although the results are limited to a descriptive report of one child whose phonologic learning was likely facilitated by the initial use of the minimal pair approach, the findings are interesting and intriguing in tracing the clinical and theoretical genesis of a different contrastive approach.

The theoretical underpinnings of multiple oppositions involve the level of phonological perspective, that is, sound versus system. The theoretical perspective of multiple oppositions views the systemic organization of a sound system as fundamental. Based on this assumption, intervention will have the greatest impact when (a) the child's phonological system and organization are described and (b) phonologic learning is directed systemically across the phonological rule or strategy. For Michelle, this was observed when multiple oppositions approached her error pattern more systemically than on a one-to-one or singular contrastive basis. A minimal pair approach may not present the child's error pattern in a way that will assist in eliminating the pattern. In contrast, a multiple oppositions approach presented the entire error pattern to Michelle. Focusing a child's attention to their pattern in this manner confronts them with the extent of phonologic change that must be learned. The multiple opposition approach has the potential of allowing the child to make connections about his or her phonologic strategies with what needs to be learned and be able to revise the strategies based on the confrontation of the new and focused phonologic information.

In addition, a multiple opposition approach is unique and specific to each child because it focuses on his or her own unique phonologic strategies. Singular contrastive approaches, such as minimal pair therapy, provide training on one isolated aspect of a child's system. As a consequence, intervention is often generic. For example, two children may receive similar minimal pair intervention for [t] ~ [k], but their phoneme collapses may reflect very different phonologic strategies. The following phoneme collapses would represent two distinct phonologic strategies despite the similarity of their errors involving [t/k]:

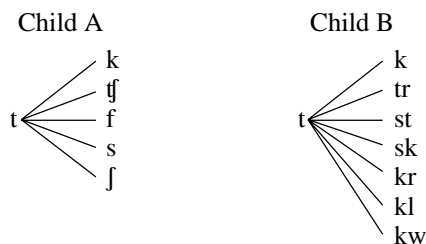

Child A collapses voiceless obstruents to [t], whereas Child B collapses the voiceless velar stop and primarily [s]

FIGURE 5. Comparison of phoneme collapses before and after intervention.

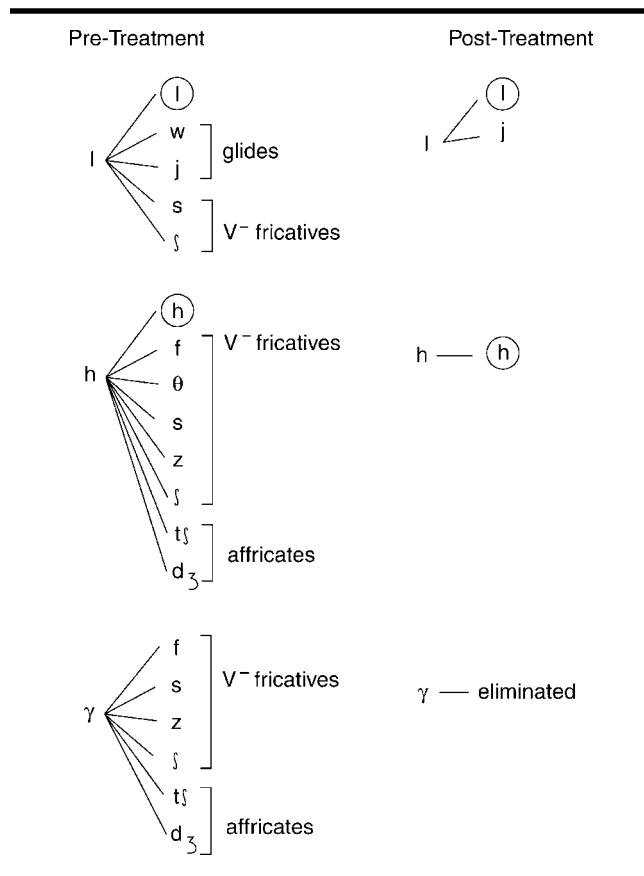
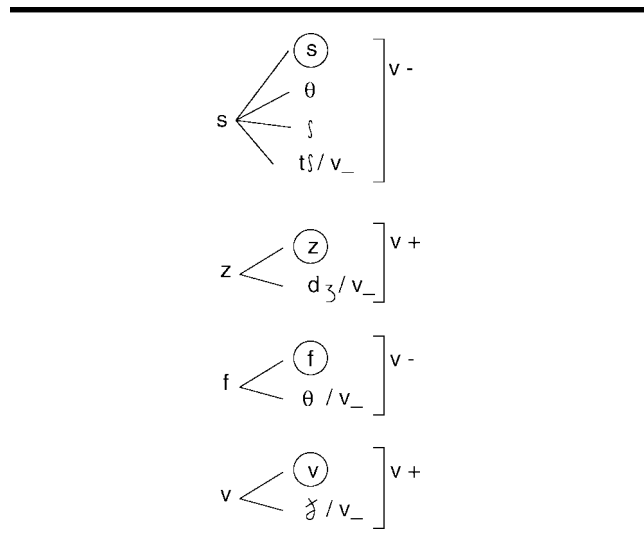

FIGURE 6. Phonological reorganization following intervention.



+ nonlabial stop and [k] clusters to [t]. A minimal pair approach that selects [t] ~ [k] contrastive pairs for both children ignores the difference in phonologic strategies developed by each child. Conversely, the multiple opposition approach would provide intervention across each

child's entire error pattern and address the specific learning needs of each child. In this example, a multiple opposition approach for Child A may incorporate [t] ~ [k, tʃ, f] to facilitate the child's learning of voiceless obstruents across the spectrum of phonemes affected by the child's rule. For Child B, a multiple opposition approach may incorporate [t] ~ [k, tr, st] in order to facilitate the child's learning of velars and the sequencing of consonants to form clusters (refer to Williams, 2000, in this issue for guidelines on selection of treatment targets).

The multiple opposition approach also appeared to match Michelle's phonological organization in terms of the progression of treatment that potentially mirrors a child's phonological reorganization. As a child's phonological system moves from multiple phoneme collapses that involve broad categories of distinction with regard to place, voice, and manner of production, the contrasts to be distinguished can shift from maximal to minimal. Furthermore, as the phoneme collapses become more restricted, the number of contrasts can shift from multiple to single oppositions. For further discussion of case studies of treatment progression, please refer to Williams (2000).

As implied by the theoretical basis of multiple oppositions, this approach also has clinical implications for the description of phonological disorders in children. The model of multiple oppositions is based on the identification and description of phonologic strategies developed by the child. This is reflected by the phoneme collapses that compare the child's system in relation to the adult system. The phoneme collapses provide a means for examining the child's organization of a limited sound system to be able to accommodate the full adult system of the ambient language. These collapses, then, can be seen as strategies the child develops to compensate for a limited sound system. Further, these collapses allow the clinician to see the logic in the child's "disordered" system or, as Grunwell (1997) states, "the order in the disorder." In the example above, Child A's system was organized to accommodate the absence of voiceless obstruents. As a consequence, Child A produces a voiceless obstruent [t] for several ambient voiceless obstruents. Child B, on the other hand, organized a system to accommodate the absence of clusters and velars. This child produced a singleton stop for several clusters involving stops and velars (singleton or clusters).

Analyses that describe a child's system by a finite set of predetermined categories or phonological processes will not identify the phoneme collapses present in a child's system. Nor will these analyses identify the organization or strategies apparent in the child's system. Rather, such analyses fragment the child's system by using a variety of distinctive features or phonological processes and miss the child's own organizational schemes (Williams, 1993). Furthermore, many collapses cannot be described by a single phonological process or there may be no phonological processes available to describe a particular error. As a result, a very disparate and fragmented description of the child's sound system is provided. Procedures that examine the child's own organization as a self-contained system lend themselves to a multiple opposition approach in which the child's system is then treated systemically.

To summarize, both singular and multiple contrastive approaches address homonymy through the use of contrastive oppositions, but approach phonological change from different theoretical perspectives that focus on different levels of phonological organization. The theoretical perspective of singular contrastive approaches, such as minimal pairs, focuses on the *level of the sound* for both the description and intervention of phonological disorders. The linguistic construct of oppositions, whether they involve minimal or maximal distinctions, is the focus of systemic phonologic learning and change. According to Gierut (1990a), it is the nature of the opposition that is deemed essential in shaping the course of phonological learning. Conversely, it is the *level of the system* that is important for the multiple opposition approach. By addressing the child's phonologic strategies, the larger treatment sets of multiple oppositions are explicitly directed at inducing change across an entire rule rather than by one contrast at a time. This theoretical perspective assumes that the greatest amount of change will occur in the shortest amount of time with the least amount of effort when intervention is focused on disruption of the original phonological pattern. In other words, *restructuring* a child's system is more efficient when the original phonological *structure* is directly addressed in intervention.

The results from this case study suggest that for some children with phonological disorders, such as Michelle, who exhibits severe phonological disorders, multiple oppositions provides a focused, systemic approach to expand the absence of phonemic contrasts. If the goal of intervention, as suggested by Grunwell (1997), is systemic expansion of the child's system through the introduction of new contrasts, multiple oppositions has the potential to meet this goal more efficiently than contrast by contrast approaches. Further investigation of this model of intervention may provide support for these clinical implications and validate the theoretical assumptions discussed herein.

Author's Note

Preparation of this paper was supported in part by a grant from the National Institutes of Health (DC03493) and a small grant from the Research and Development Committee at East Tennessee State University. Portions of this paper were presented at the annual convention of the American Speech-Language-Hearing Association, Seattle, 1990.

References

Camarata, S. M., & Gandour, J. (1984). On describing idiosyncratic phonologic systems. *Journal of Speech and Hearing Disorders, 49*, 262–266.

- Cooper, R.** (1968). The method of meaningful minimal contrasts in functional articulation problems. *Journal of the Speech and Hearing Association of Virginia, 10*, 17–22.
- Elbert, M., & Gierut, J.** (1986). *Handbook of clinical phonology: Approaches to assessment and treatment*. San Diego, CA: College-Hill Press.
- Elbert, M., Rockman, B., & Saltzman, D.** (1980). *Contrasts: The use of minimal pairs in articulation training*. Austin, TX: Exceptional Resources.
- Ferrier, E., & Davis, M.** (1973). A lexical approach to the remediation of final sound omissions. *Journal of Speech and Hearing Disorders, 38*, 126–130.
- Gierut, J. A.** (1990a). Differential learning of phonological oppositions. *Journal of Speech and Hearing Research, 33*, 540–549.
- Gierut, J. A.** (1990b). Linguistic foundations of language teaching: Phonology. *Journal of Speech-Language Pathology and Audiology, 14*, 5–21.
- Gierut, J. A., Elbert, M., & Dinnsen, D. A.** (1987). Functional analysis of phonological knowledge and generalization learning in misarticulating children. *Journal of Speech and Hearing Research, 30*, 462–479.
- Grunwell, P.** (1995). Changing phonological patterns. *Child Language Teaching and Therapy, 11*(1), 61–78.
- Grunwell, P.** (1997). Developmental phonological disability: Order in disorder. In B. W. Hodson & M. L. Edwards (Eds.), *Perspectives in applied phonology*. Gaithersburg, MD: Aspen Publications.
- Ingram, D.** (1991). Toward a theory of phonological acquisition. In J. F. Miller (Ed.), *Research on child language disorders: A decade of progress*. Austin, TX: Pro-Ed.
- Macher, A. G.** (1990). *A comparison of the effects of deep training vs. broad training on generalization learning*. Unpublished manuscript, California State University at Fullerton.
- Weiner, F.** (1981a). Treatment of phonological disability using the method of meaningful minimal contrast: Two case studies. *Journal of Speech and Hearing Disorders, 46*, 97–103.
- Weiner, F. F.** (1981b). Systematic sound preference as a characteristic of phonological disability. *Journal of Speech and Hearing Disorders, 46*, 281–286.
- Williams, A. L.** (1993). Phonological reorganization: A qualitative measure of phonological improvement. *American Journal of Speech-Language Pathology, 2*(2), 44–51.
- Williams, A. L.** (2000). Multiple oppositions: Case studies of variables in phonological intervention. *American Journal of Speech-Language Pathology, 9*, 289–299.

Received December 20, 1999

Accepted August 2, 2000

Contact author: A. Lynn Williams, PhD, Department of Communicative Disorders, P.O. Box 70643, East Tennessee State University, Johnson City, TN 37614.
E-mail: williaml@etsu.edu